

Anycubic Kobra Go

▶ User Manual

Dear customer,

Thank you for choosing Anycubic products.

Maybe you are familiar with 3D printing technology or have purchased Anycubic printers before, but we still highly recommend that you read this manual carefully. The installation techniques and precautions in this manual can help you avoid any unnecessary damage or frustration.

Please visit <https://support.anycubic.com/> to contact us if you have any question. You can also gain more information such as software, videos, models from the website.



Anycubic Support Center

Team Anycubic

Copyrighted by “Shenzhen Anycubic Technology Co., Ltd ” , all rights reserved.

Contents

Safety Instructions	4
Technical Specification	5
Packing List	7
Product Overview	8
Menu Directory	11
Installation	12
Software	13
Resume from Outage	29
Maintenance	30
Troubleshooting	31

Safety Instructions

To avoid any unnecessary damage to the printer or individual injury, please always follow the safety instructions when assembling and using the machine.



Please contact our customer service first if you have any problem after receiving the products.



Be cautious when using the scraper. Never direct the scraper towards your hand.



In case of emergency, please immediately cut off the power of Anycubic 3D printer and contact the technical support.



Anycubic 3D printer includes high speed running parts that can cause injury.



Anycubic 3D printer generates high temperature. Do not reach the printing area during operation.



It is recommended to use protection glasses when cleaning/sanding the printed models to avoid small particles in eyes.



Keep the Anycubic 3D printer and its accessories out of the reach of children.



Vapors or fumes may be irritating at operating temperature. Always use the Anycubic 3D printer in an open and well ventilated area.



Anycubic 3D printer must not be exposed to water or rain.



Anycubic 3D printer is designed to be used within ambient temperature ranging 8°C-40°C, and humidity ranging 20%-50%. Working outside those limits may result in low quality printing.



Do not disassemble Anycubic 3D printer, please contact technical support if you have any question.

Technical Specification

Printing

Technology	FDM (Fused Deposition Modeling)
Build Size	220 mm(L) × 220 mm(W) × 250 mm(H)
Layer Thickness	0.05 - 0.3 mm
Positioning Accuracy	X / Y / Z 0.0125 / 0.0125 / 0.00125 mm
Extruder Quantity	Single
Nozzle Diameter	0.4 mm
Supported Materials	PLA, ABS, HIPS, TPU, Wood, etc

Temperature

Ambient Operating Temperature	8 °C - 40 °C
Operational Extruder Temperature	Max 260 °C 200 °C is suggested for PLA 230 °C is suggested for ABS 190 °C is suggested for TPU
Operational Print Bed Temperature	Max 110 °C 60 °C is suggested for PLA 80 °C is suggested for ABS 60 °C is suggested for TPU

Technical Specification

Software

Slicing Software	Cura, Simplify3D, Repetier-HOST
Software Input Formats	.STL, .OBJ, .JPG, .PNG
Software Output Formats	GCode
Connectivity	Memory card; Data cable (expert users only)

Electrical









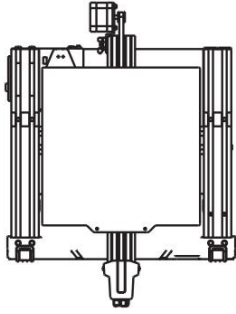
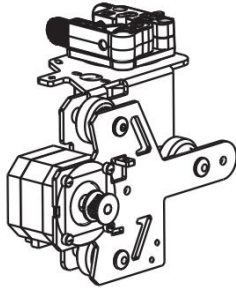
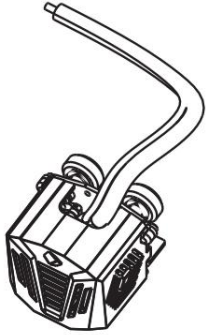

Power Input	110 V / 220 V AC, 50 / 60 Hz
Rated Power	400 W

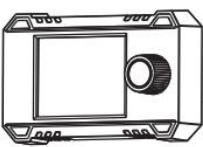
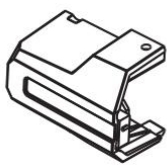
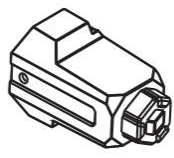
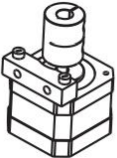
Physical Dimensions

Printer Dimensions	445 mm(L) × 443 mm(W) × 490 mm(H)
Net Weight	~7.3 kg



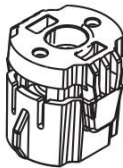
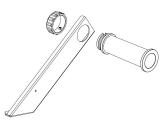
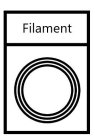

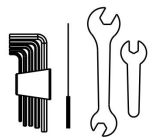





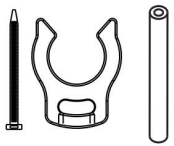

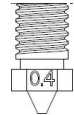
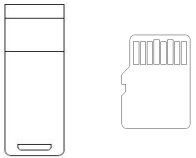





























































Packing List

			
Printer base	XE axis kit	Print head	
			
Z-axis passive block	Screen kit	X-axis limit switch kit	X-axis tensioner
			
Z-axis motor kit	Top beam	X-axis profile	Z-axis profile(left)
			
Z-axis profile(right)	T-shaped screw rod	Anti-Backlash Nut	Filament Holder
			
Assembly Instruction	Assembly Instruction	Lubricant	Tool Kit

* All pictures shown are for illustrative purposes only. The actual product may vary due to product optimization.

Packing List

																											
<p>Spare buckles and cable ties, Teflon tube</p>	<p>Power cord</p>	<p>Spare nozzle</p>																									
																											
<p>Card Reader Memory Card</p>	<p>Photoelectric switch blank</p>	<p>Synchronous belt</p>	<p>Height gauge</p>																								
<table border="0"> <tr> <td data-bbox="149 901 449 942">  M3X5*3 </td> <td data-bbox="578 901 835 942">  M3X8*2 </td> <td data-bbox="942 901 1228 942">  M4X6*2 </td> </tr> <tr> <td data-bbox="242 984 307 1046">  17 </td> <td data-bbox="656 984 721 1046">  18 </td> <td data-bbox="1021 984 1085 1046">  19 </td> </tr> <tr> <td data-bbox="149 1087 449 1129">  M4X16*2 </td> <td data-bbox="578 1087 863 1129">  M4X16*5 </td> <td data-bbox="942 1087 1256 1129">  M4X20*2 </td> </tr> <tr> <td data-bbox="242 1170 307 1232">  20 </td> <td data-bbox="656 1170 721 1232">  21 </td> <td data-bbox="1021 1170 1085 1232">  22 </td> </tr> <tr> <td data-bbox="149 1263 464 1305">  M5X25*2 </td> <td data-bbox="578 1263 863 1305">  M5X16*4 </td> <td data-bbox="921 1263 1263 1305">  M5X45*2 </td> </tr> <tr> <td data-bbox="242 1346 307 1408">  23 </td> <td data-bbox="656 1346 721 1408">  24 </td> <td data-bbox="1021 1346 1085 1408">  25 </td> </tr> <tr> <td data-bbox="149 1471 556 1543">  M5 Spring washer*4 </td> <td data-bbox="585 1471 885 1543">  M4 Washer*3 </td> <td></td> </tr> <tr> <td data-bbox="242 1564 307 1626">  26 </td> <td data-bbox="656 1564 721 1626">  27 </td> <td></td> </tr> </table>				 M3X5*3	 M3X8*2	 M4X6*2	 17	 18	 19	 M4X16*2	 M4X16*5	 M4X20*2	 20	 21	 22	 M5X25*2	 M5X16*4	 M5X45*2	 23	 24	 25	 M5 Spring washer*4	 M4 Washer*3		 26	 27	
 M3X5*3	 M3X8*2	 M4X6*2																									
 17	 18	 19																									
 M4X16*2	 M4X16*5	 M4X20*2																									
 20	 21	 22																									
 M5X25*2	 M5X16*4	 M5X45*2																									
 23	 24	 25																									
 M5 Spring washer*4	 M4 Washer*3																										
 26	 27																										

* All pictures shown are for illustrative purposes only. The actual product may vary due to product optimization.

Product Overview

Front

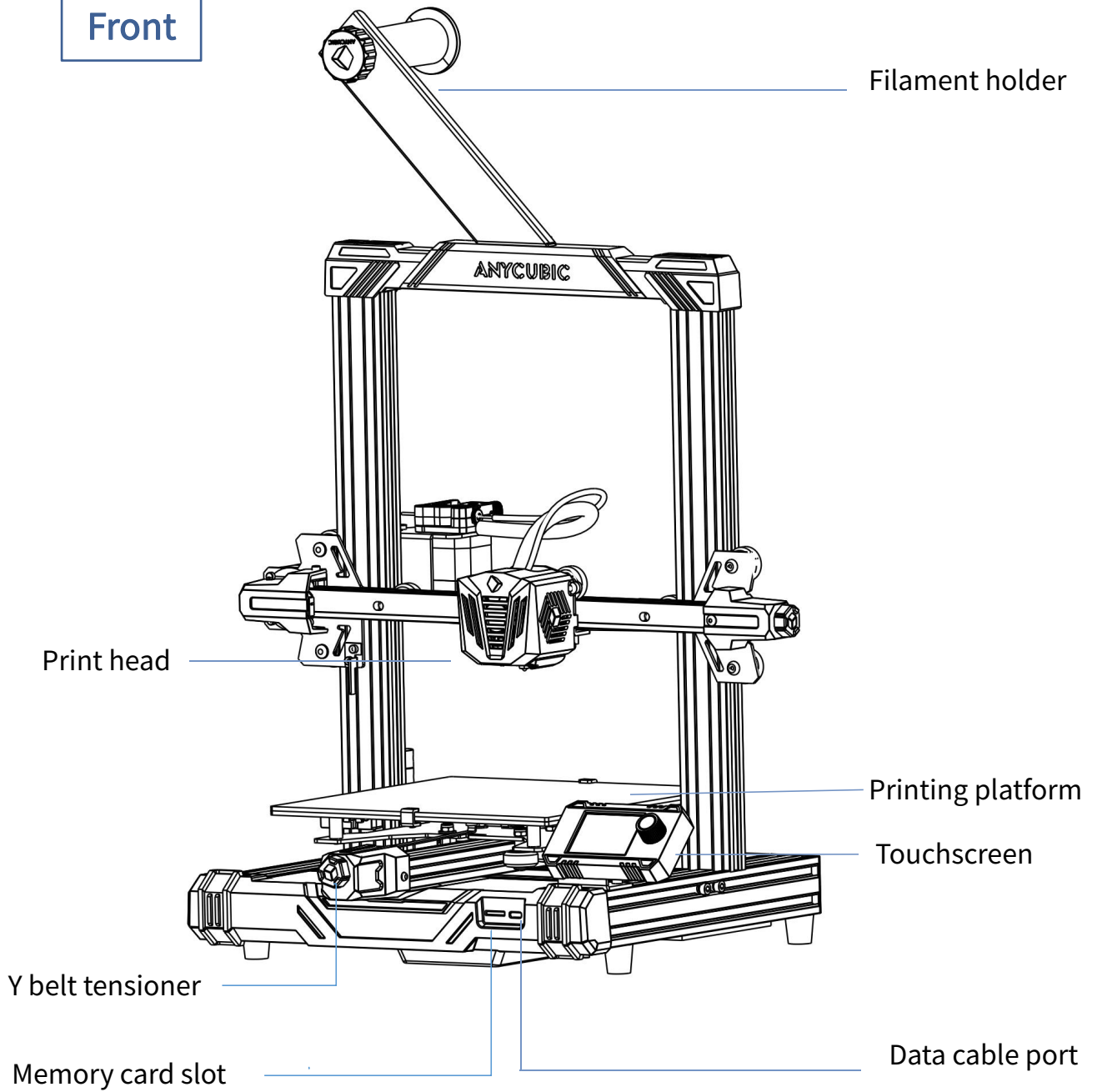

Product Overview

Back

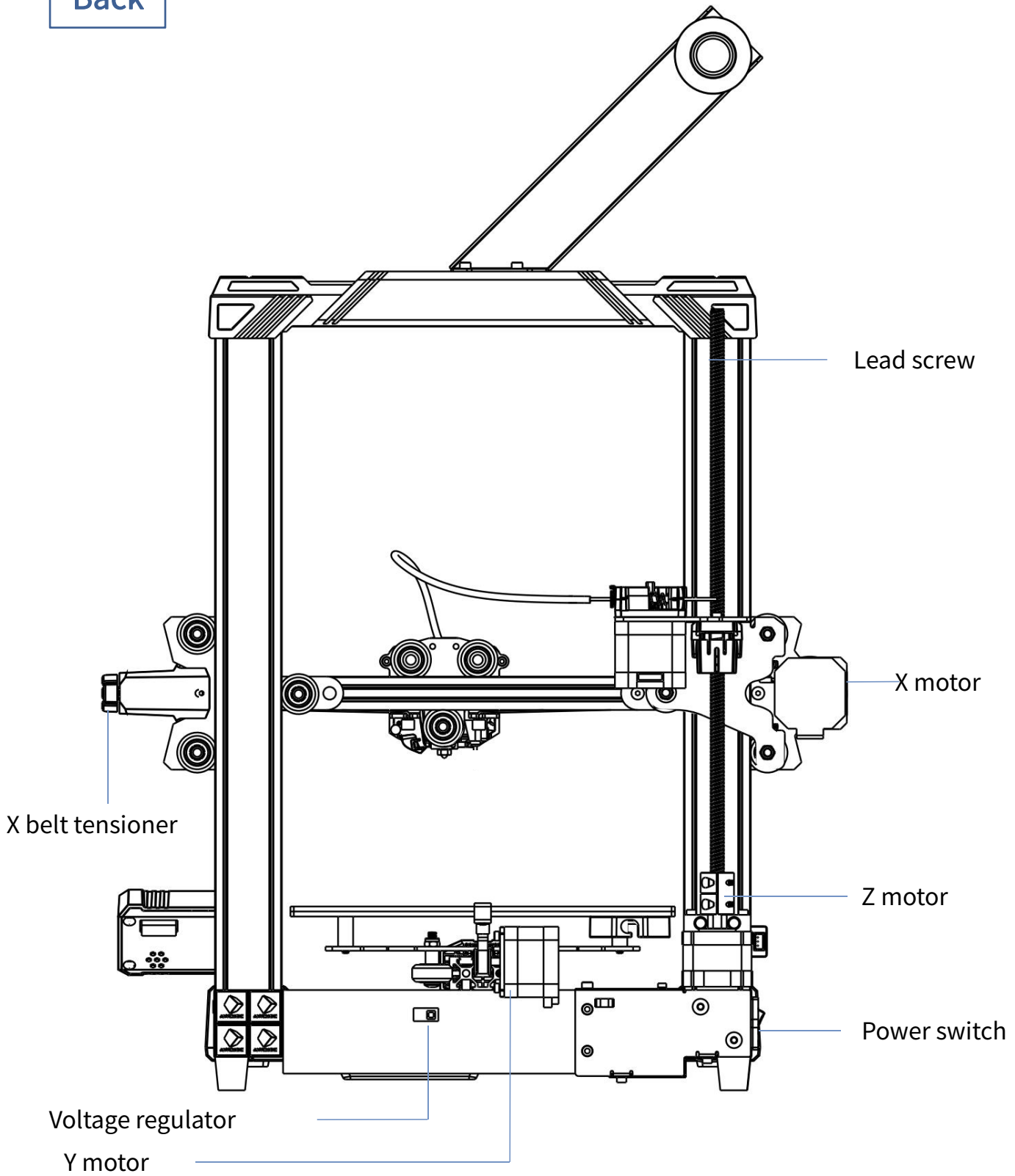

Menu Directory

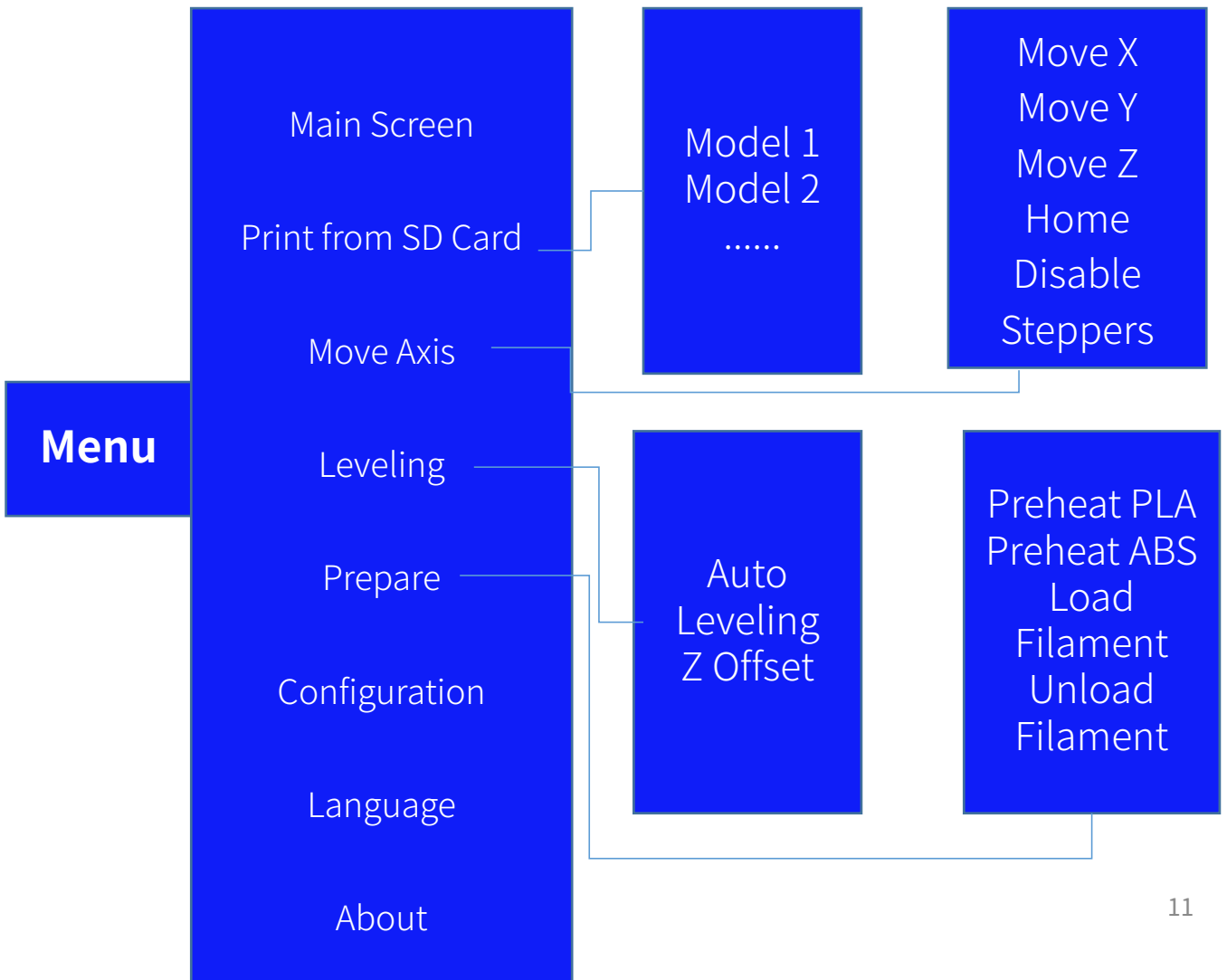
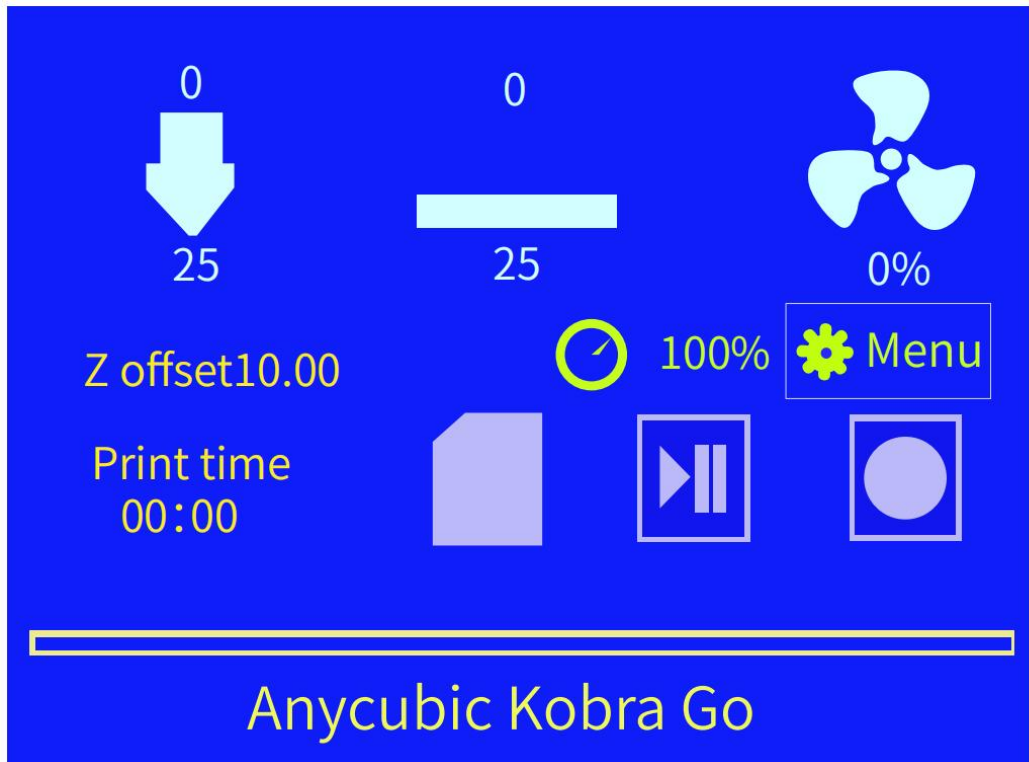

Installation

1. For detailed installation procedures, refer to the installation instructions in the attachment.
2. Be cautious during assembly as some parts may have sharp edges.
3. It is suggested to use a flat desktop and place the parts in an orderly manner for quick assembly.
4. The color of some parts may be different from what in the manual, but the assembly is the same.
5. Firmware has been pre-uploaded to the motherboard. After completing the assembly, please level the platform and load the filament then you could start the first test print.

Note: Every unit of the printer has been inspected and tested for printing. Therefore, in some cases, there might be very small marks left on the print head or on the heated bed. Those will not affect the printing quality and those mean the printer has been tested for the quality. If there are some tiny scratches on the aluminum beams or slight unevenness on the platform, it is normal and won't affect the printing quality. Thank you very much for your kind understanding.

Team **ANYCUBIC**

Introduction to slicing software

3D printer reads GCode file and prints. It is necessary to convert 3D files (such as stl file) into GCode files for machine to recognize. Software that convert 3D files into GCode files is called slicing software.

Introduction of slicing software:

1. Cura Installation
2. Machine Settings
3. Import the Configuration File
4. Manipulate 3D model in Cura
5. Slice and Preview
6. Print Offline and Online

1. Cura Installation

Double click **Ultimaker_Cura-4.12.0-win64**, and follow the steps as shown below.

* Ultimaker Cura 4.12.0 is used for example here, please refer to the memory card for the actual version.

* File path: Memory card → “Files_ English_Anycubic Kobra Go” → “Cura” → “Windows” or “Mac” .

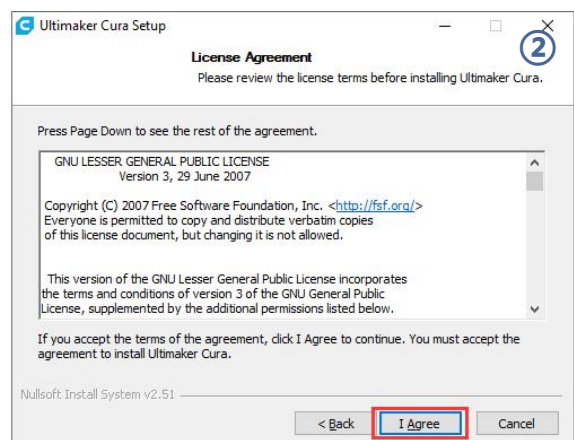
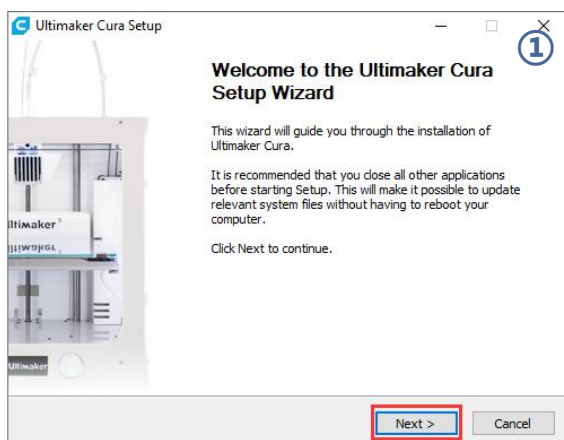

Introduction to slicing software

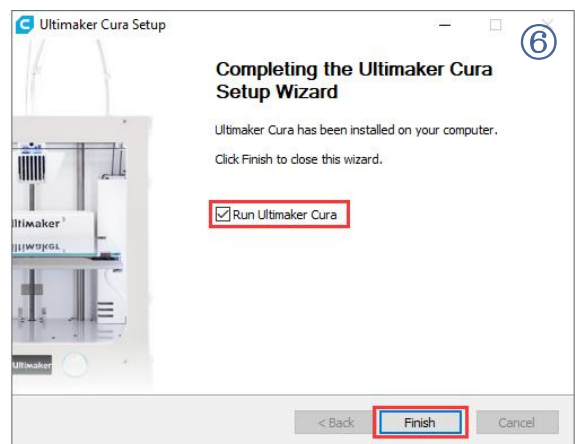
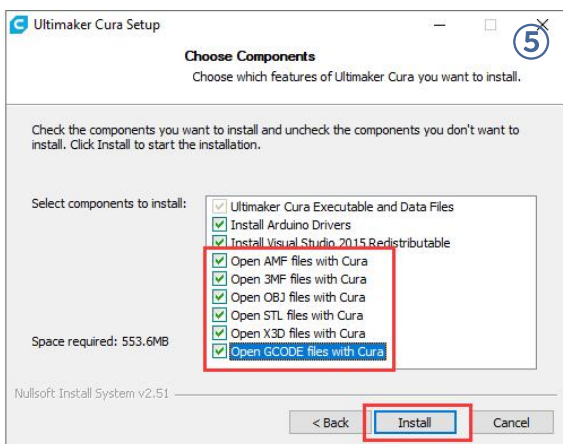
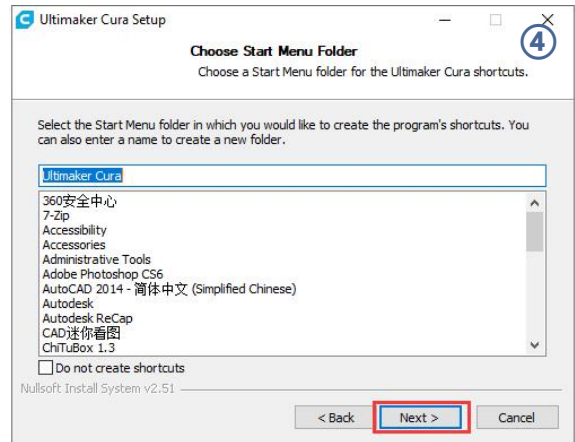
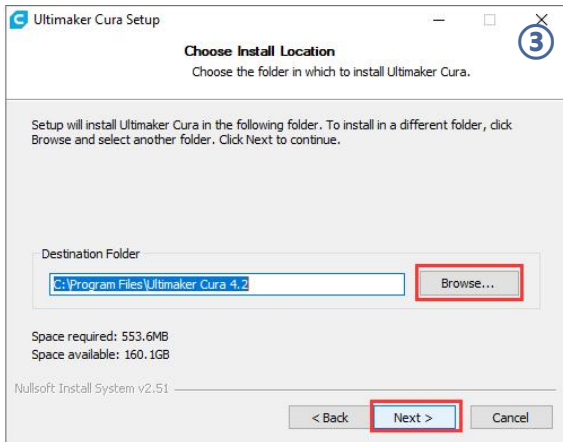

* Printing online requires the installation of a driver, as shown below. If you don't print online, you don't need to install it.

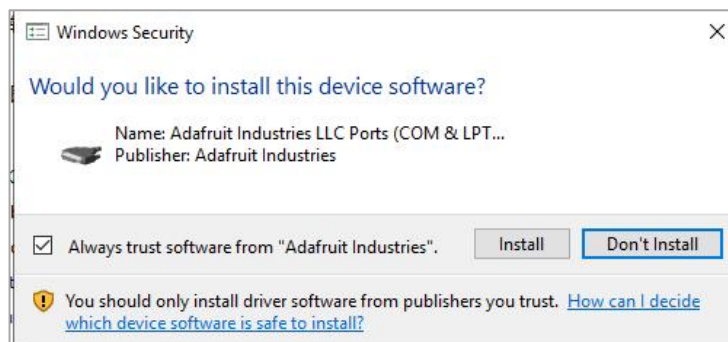

2. Machine Settings

Upon completion of installation, the first launch of the software will display the following welcome screen. Click **Get started** to start the machine settings.

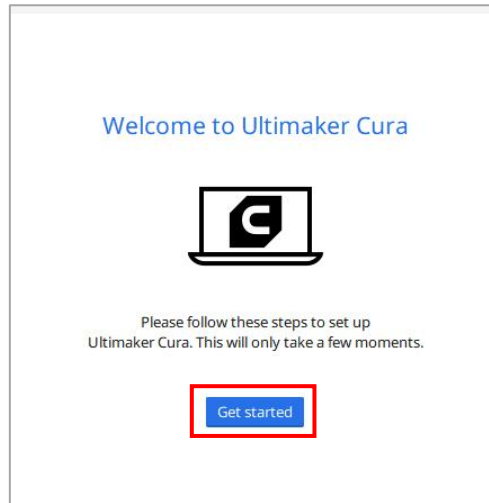

① User Agreement

Disclaimer by Ultimaker

Please read this disclaimer carefully.

Except when otherwise stated in writing, Ultimaker provides any Ultimaker software or third party software "As is" without warranty of any kind. The entire risk as to the quality and performance of Ultimaker software is with you.

Unless required by applicable law or agreed to in writing, in no event will Ultimaker be liable to you for damages, including any general, special, incidental, or consequential damages arising out of the use or inability to use any Ultimaker software or third party software.

[Decline and close](#) [Agree](#)

② What's new in Ultimaker Cura

4.12.0

Orthographic view.
When preparing prints, professional users wanted more control over the 3D view type, so this version introduces an orthographic view, which is the same view type used by most professional CAD software packages. Find the orthographic view in View > Camera view > Orthographic, and compare the dimensions of your model to your CAD design with ease.

Object list.
Easily identify corresponding filenames and models with this new popup list. Click a model in the viewport and its filename will highlight, or click a filename in the list and the corresponding model will highlight. The open or hidden state

[Next](#)

Introduction to slicing software

③ Help us to improve Ultimaker Cura

Ultimaker Cura collects anonymous data to improve print quality and user experience, including:

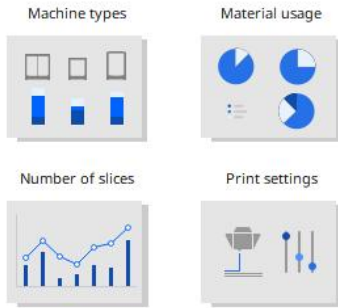

Data collected by Ultimaker Cura will not contain any personal information. [More information](#)

Next

④ Add a printer

Add a networked printer

There is no printer found over your network.

Refresh

Add printer by IP

Troubleshooting

Add a non-networked printer

Next

⑤

Add a printer

Add a networked printer

Add a non-networked printer

Ultimaker B.V.

Custom

- Custom FFF printer
- Smoothie Custom Printer

- > 101Hero
- > 3Dator GmbH
- > 3Deometry Innovations
- > 3DMaker
- > 3DTech
- > Abax 3D Technologies
- > Alfawise
- > Anet

Custom FFF printer

Manufacturer: Custom

Profile author: Ultimaker

Printer name: Anycubic Kobra Go

Cancel

Add

Machine Settings

Anycubic Kobra Go

⑥ **Printer** Extruder 1

Printer Settings

X (Width)	222.0	mm
Y (Depth)	222.0	mm
Z (Height)	250.0	mm
Build plate shape	Rectangular	▼
Origin at center	<input type="checkbox"/>	
Heated bed	<input checked="" type="checkbox"/>	
Heated build volume	<input type="checkbox"/>	
G-code flavor	Marlin	▼

Printhead Settings

X min	-20	mm
Y min	-10	mm
X max	10	mm
Y max	10	mm
Gantry Height	250.0	mm
Number of Extruders	1	▼
Apply Extruder offsets to GCode	<input checked="" type="checkbox"/>	

Start G-code

```
G28 ;Home  
G1 Z15.0 F6000 ;Move the platform down 15mm
```

End G-code

```
G28 X0 Y0  
M84
```

Next

⑦

Machine Settings

Anycubic Kobra Go

Printer **Extruder 1**

Nozzle Settings

Nozzle size	0.4	mm
Compatible material diameter	1.75	mm
Nozzle offset X	0.0	mm
Nozzle offset Y	0.0	mm
Cooling Fan Number	0	

Extruder Start G-code

Extruder End G-code

Next

⑧

Ultimaker Cloud



The next generation 3D printing workflow

- Send print jobs to Ultimaker printers outside your local network
- Store your Ultimaker Cura settings in the cloud for use anywhere
- Get exclusive access to print profiles from leading brands

[Create an account](#)

[Sign in](#)

[Finish](#)

3. Import the Configuration File

After continuous testing, we provided users the suggested printing parameters of different filaments for Anycubic Kobra Go, and the user could directly import the parameter files to the software.

(1) Click **Settings** → **Configure setting visibility...**, and then tick **Check all** box to make all settings visible.

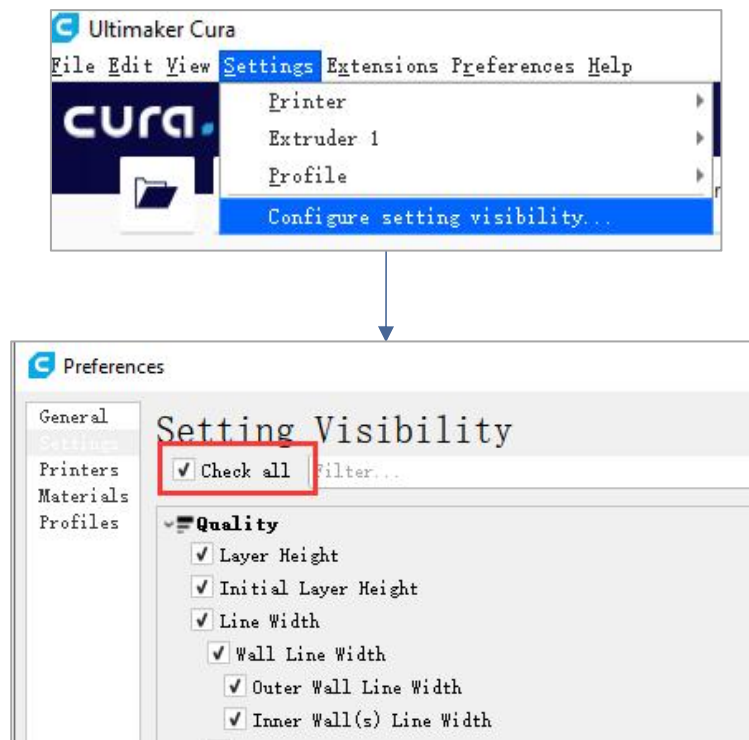

(2) In the same interface opened in Step (1), click **Profiles** on the left side. Then click **Import** button to import the desired print profile.

- * Choose different parameter profiles according to different filament types.
- * The provided profiles only match Cura 4.12.0.
- * Profile path: Memory card → "Files _ English _ Anycubic Kobra Go" → "Suggested Parameters Profiles"

Introduction to slicing software

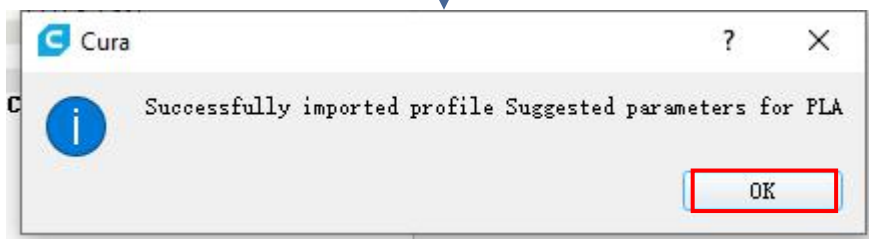
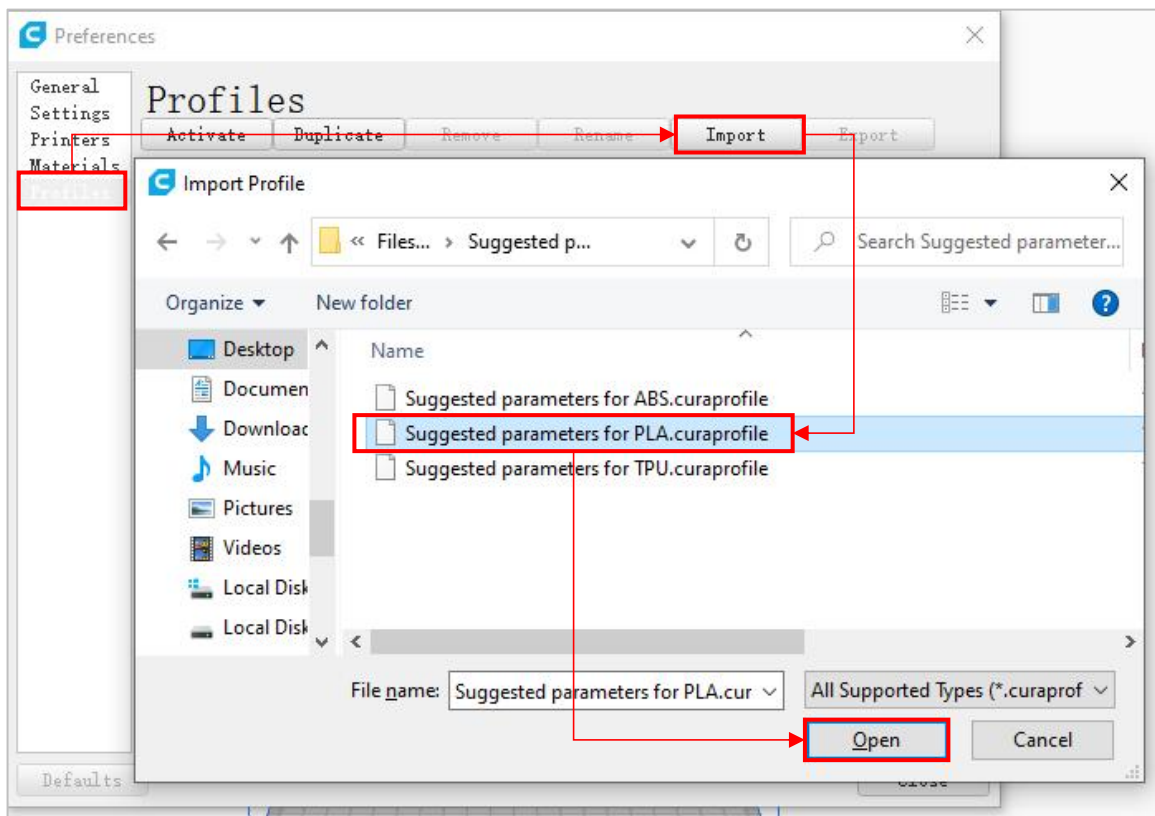

(3) Select the profile that you just imported, PLA, and then click the **Activate** button.

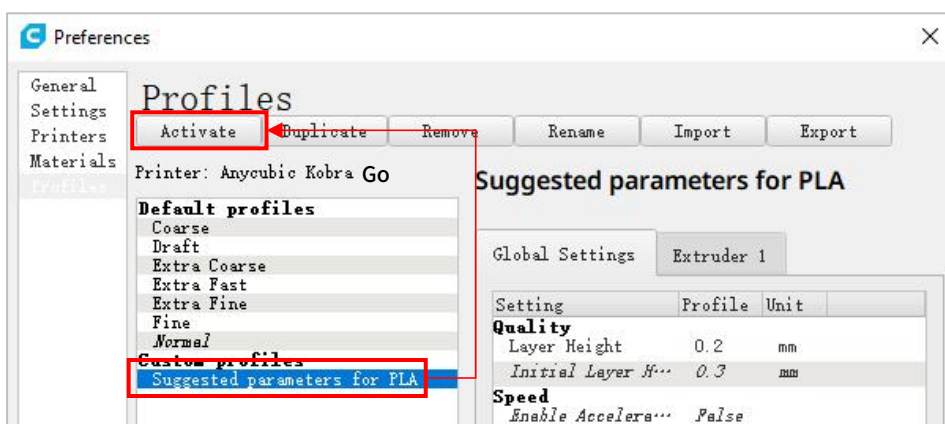

* Note: An interface may pop up after clicking the **Activate** button. If so, please check the values of listed parameters. You can click **Keep** to keep the custom values or click **Discard** to enable the values in the profile.

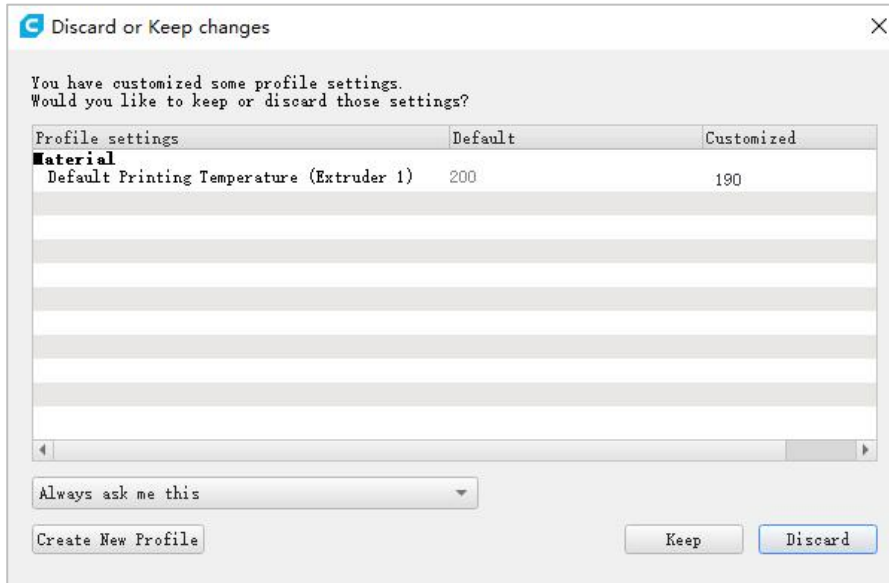

Supplementary Explanation

- ① You can customize some parameters after importing the profile, but we still recommend that you use the parameters in the profile that we provide.

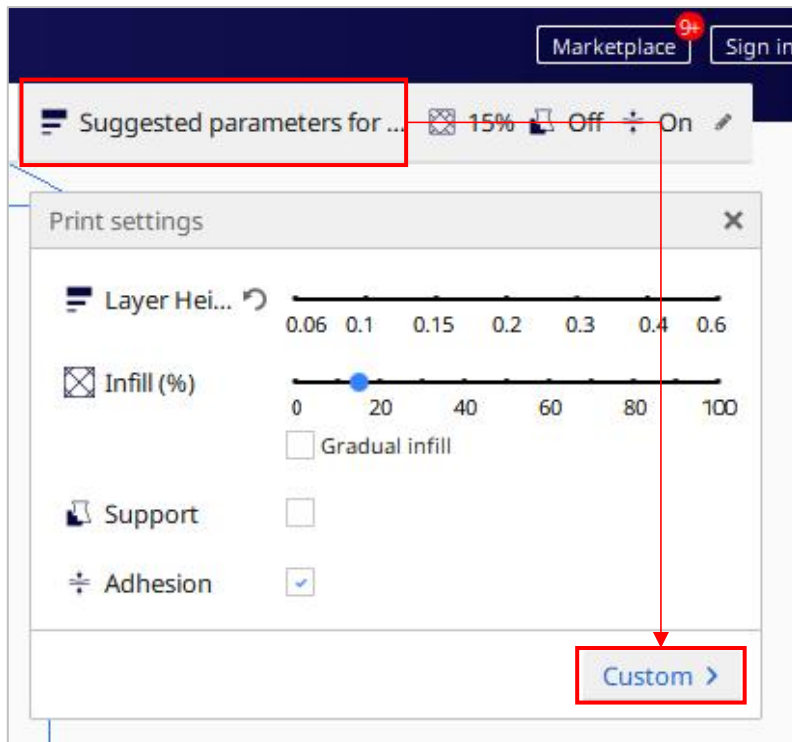

- ② The parameter **Build Plate Adhesion** → **Build Plate Adhesion Type** needs to be set to “None” when you print the maximum size model.

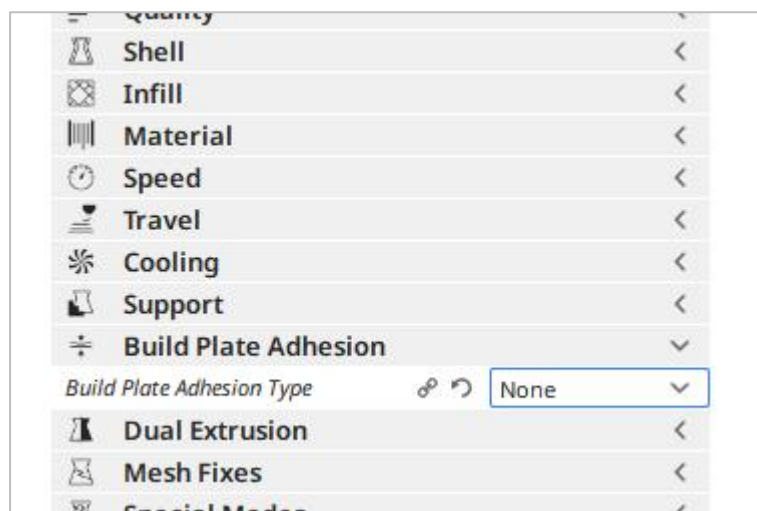

4. Manipulate 3D model in Cura

* Model files can be downloaded from www.anycubic.com (ANYCUBIC website) and www.thingiverse.com.

(1) Click the open file button in the top left corner to import the model file or directly drag the file into the software.

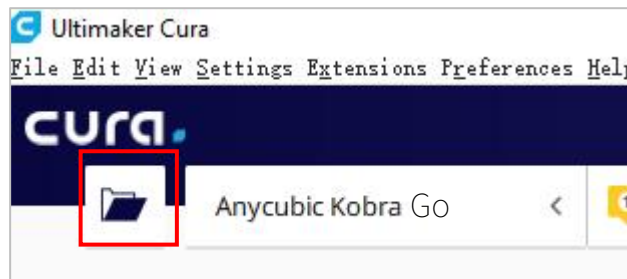

(2) Left click the model to activate the adjustment tool on the left side of the interface. Choose one of the adjustment tool, and then click and drag the controls on the model to adjust it.

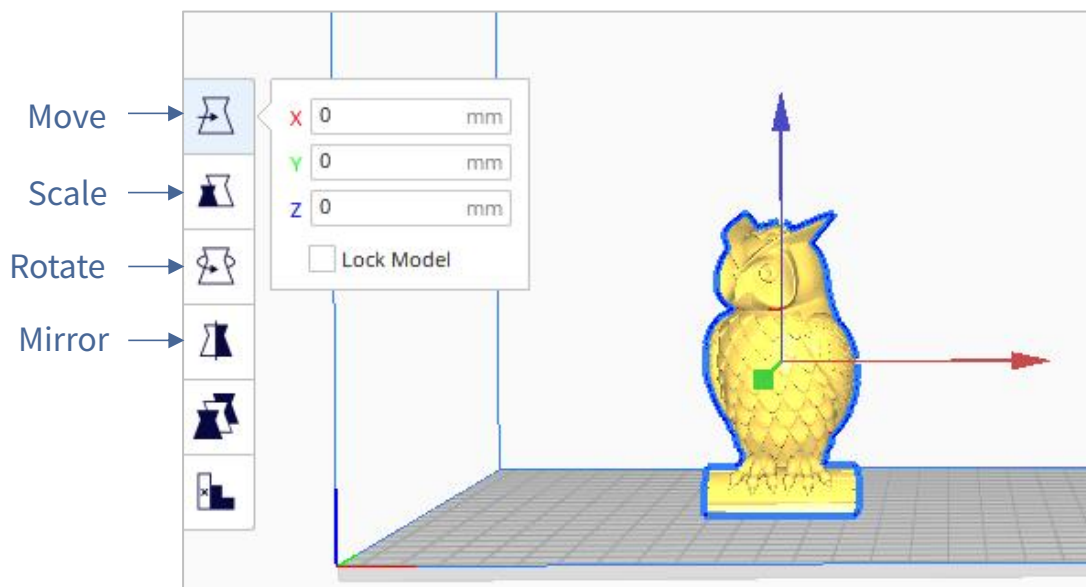

The model name: owl

The author of the model: etotheipi

Other operations:

- ① Press the mouse wheel and move the mouse to move the platform.
- ② Scroll the mouse wheel to zoom in and out the platform.
- ③ Right click and move the mouse to change the viewing angle.

* Note: When moving the model, make sure that the model is in the printable area. The color of the model in the following figure indicates that the model is out of print range.

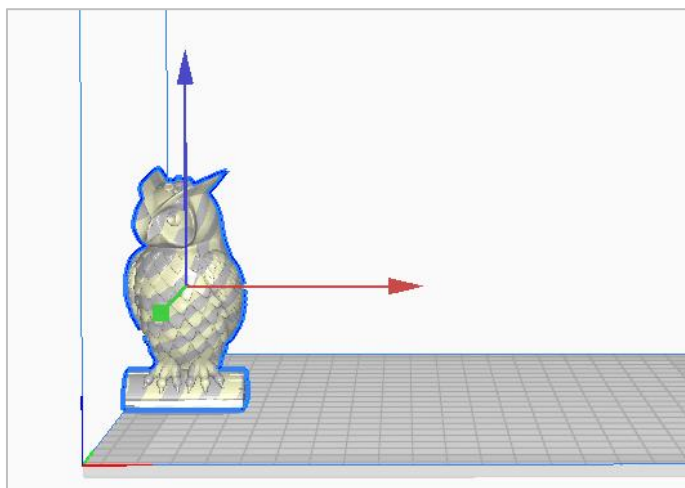

5. Slice and Preview

Now that the configuration and print settings are in place, it's time to slice the model. Click **Slice** button in the bottom right corner. When the process completes, it will immediately show a **Preview** button, click it to go to the preview stage.



Introduction to slicing software

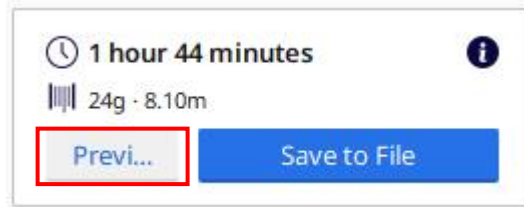

Use the layer slider and simulation view to check important parts of your 3D slice.

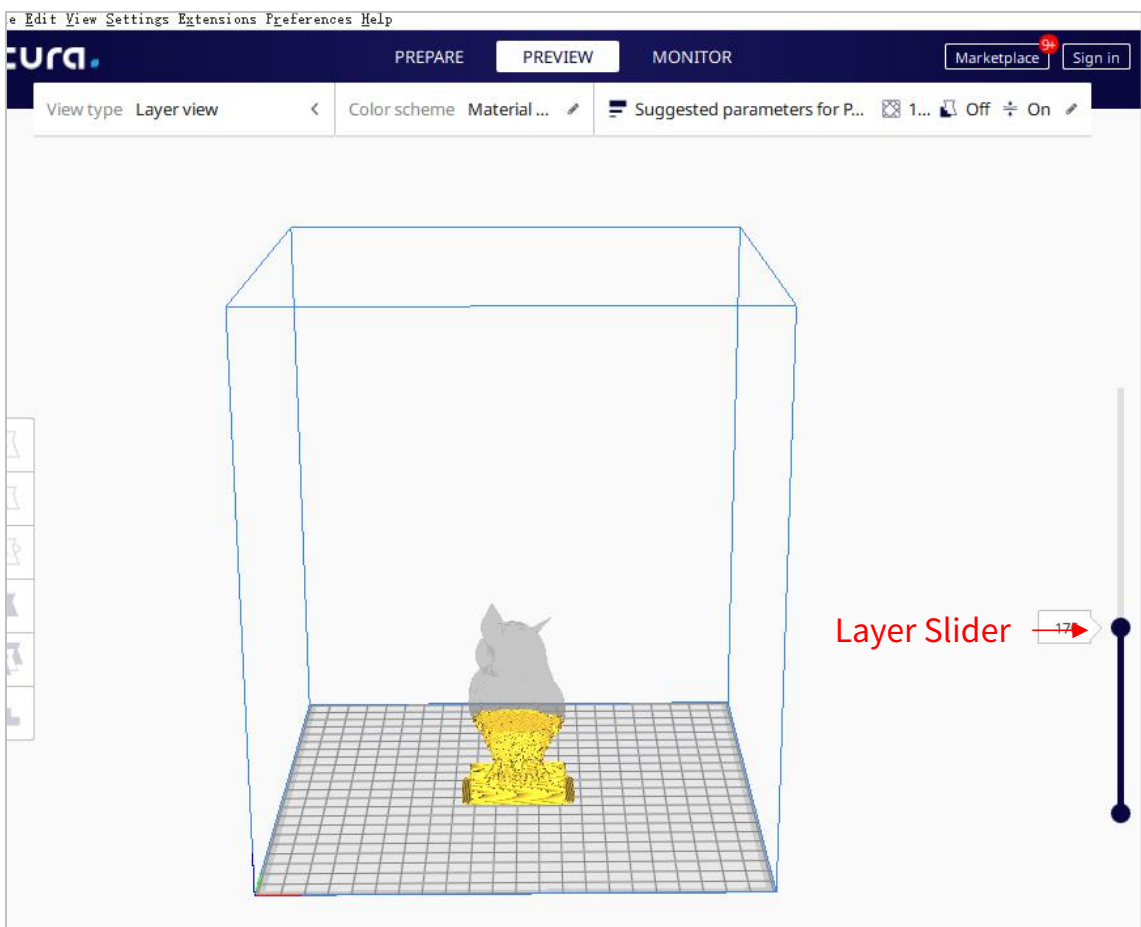

6. Print offline and online

There are two operational modes for Anycubic Kobra Go: print offline and print online.

- **Print offline:** Insert memory card into the memory card slot, click on the Home Menu “Print” to enter the file list, and print a selected file (GCode files ONLY).
- **Print online:** Install CH340 driver to bridge PC and machine, and install Cura for slicing and control the machine to print via data cable.

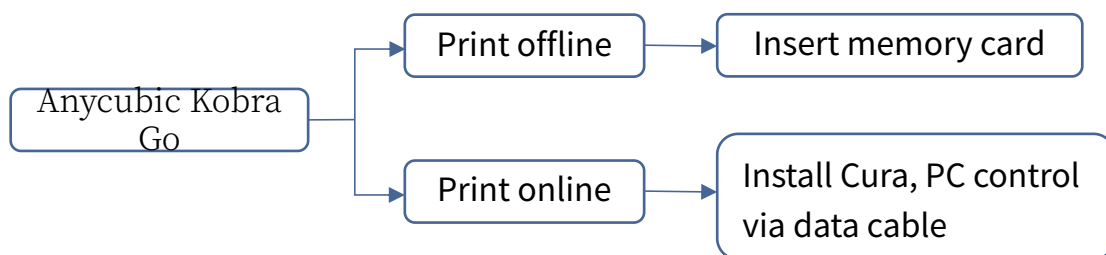

It is suggested to use **Print Offline** mode to minimize the noisy signal via data cable.

● Print offline (Recommended)

After slicing, click **Save to File** in the bottom right corner. Save the GCode file to the memory card, and then insert the memory card to the printer and control via the touch screen for offline printing.

* GCode file name should only contain English letters, underscore and space. File name contains special characters could not be recognized by the printer. In order to let the printer better recognize the GCode file in the memory card, you need to back up all the files in the memory card to the computer, and keep the memory card only for the GCode file. Please save all the GCode files in root directory of the memory card.

Introduction to slicing software

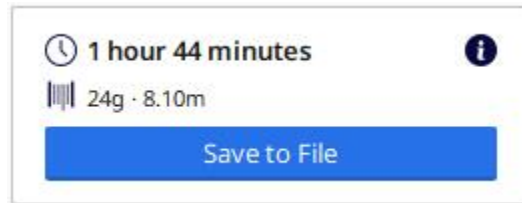

● Print online

Printing online requires the installation of a driver. And you can control the printer through Cura after connecting the data cable.

(1) Turn on the machine, connect the printer (data cable port) and your PC via data cable. The driver may not be installed automatically, so it is required to check that. Right-mouse click “This PC” → “Properties” → “Device manager” , if there is an exclamation mark as shown below, then it needs to be installed manually.

* Anycubic Kobra Go uses CH340 chip for communication.

* CH340 driver file path: “Files_English_Ancubic Kobra Go” → “Driver_CH341” . There are two versions, Windows and Mac version. (* CH341 driver file is suitable for CH340 chip).

Exclamation Mark

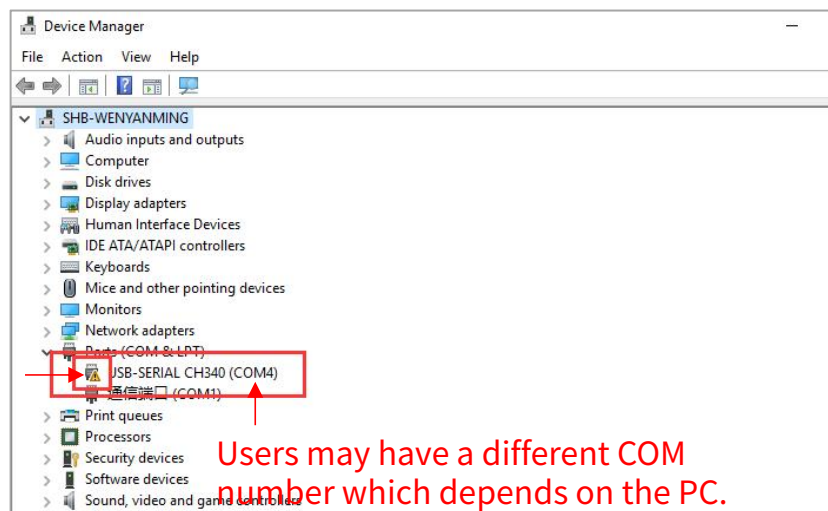

Users may have a different COM number which depends on the PC.

Introduction to slicing software

(2) Here we take Windows PC system for example. Double click “CH341SerSetup.exe” and follow the wizard to install it. **If the driver has installed automatically in step (1), skip this step.**

* After the installation is completed, refer to the method in step (1) to see if the driver has been identified (no exclamation mark).

(3) After slicing, click **Print via USB** in the bottom right corner to go to the monitor stage. After waiting for about ten seconds, the operation panel will be displayed on the right side of the interface. And the printing platform will be heated up for printing.

* If the printer is not connected properly, the Monitor interface will be blank. Please plug the data cable to connect again.

* In the process of printing, do not plug the data cable, or it will interrupt the printing.

* In case of abnormal sound during the printing process, you can directly turn off the power of the machine. Please check the Troubleshooting chapter for more detail or contact Customer Service.

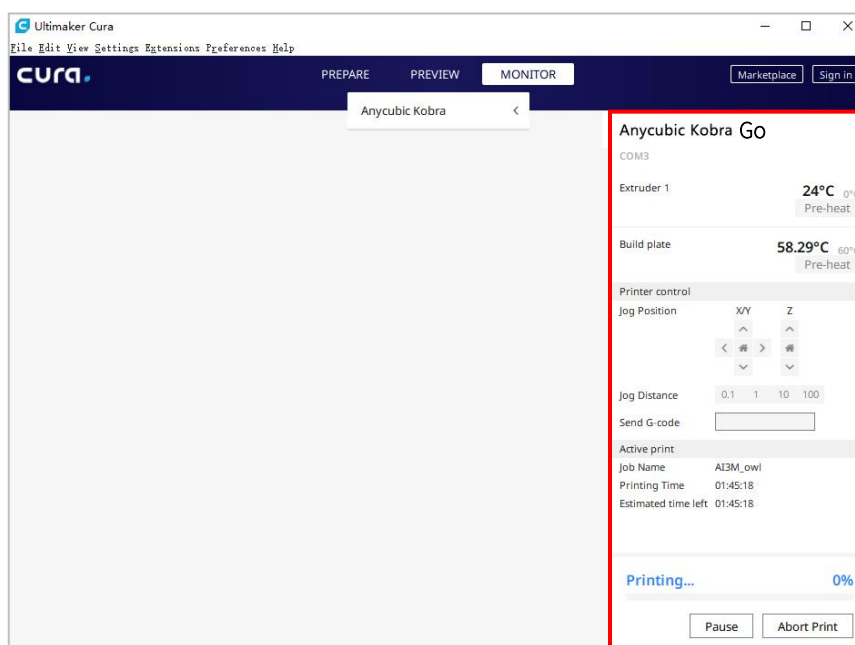

Resume from Outage

In case of a power loss during printing, the machine will automatically save the printing status. After restarting, you will see the interface shown below, please click "Continue" to continue your printing or "Cancel" to cancel it.

Maintenance

It is necessary to perform routine maintenance to the 3D printer to achieve consistent and quality results.

Some maintenance suggestions are shown as below:

1. Clean the nozzle with a needle under preheating conditions. If the filament residue in the nozzle could not be cleared 100%, please replace the nozzle.
2. Regularly add lubricating oil to smooth rods, linear bearings, lead screws, brass nuts, etc. It can minimize the wear-out failure of those moving parts.
3. Regularly clean the filament residue and dirt on the nozzle, platform, guide rail, motor, fan, etc.
4. Pay attention to the wear conditions of the D-shape wheels. Although they could be used for long time, please replace the D-shape wheels if they have been wore-out.
5. After finishing a printing, clean the printing platform to ensure the adhesion of the bottom layer of the model for next printing.
6. Check the belts regularly and tighten them if necessary.

1. Motor shaking or abnormal sound

- ① The motor cable are not connected properly. Please Check each connection and then inspect the cable routing for any faults.
- ② Drive current is too large / small (please contact customer service).
- ③ The motor is damaged.
- ④ The motor driving wheel is loose.
- ⑤ The belt is loose, please check the belt tension at each position of X/Y/Z. And whether the belt is slippery during motor movement or not.

2. File not printing or memory card failure

- ① Remove the memory card and insert into PC. Open the GCode files using text editor (eg. Notepad), and inspect if GCode is readable or not. If file contains of multiple “ÿÿÿ” symbol, then file has been corrupted. Try reformatting the memory card to FAT32 format and reloading the GCode file.
- ② Memory card is not readable, ensure file name does not contain special characters or Change memory card.
- ③ Touch screen freeze, reboot the machine and try again.

3. No extrusion or extrusion motor knocking

- ① Filaments tangled on spool or the Teflon tube is out of shape. Please straighten out the filaments and Teflon tube, and pull the filaments to observe whether the resistance is normal.
- ② Ensure that the nozzle temperature has been set to match the filament. (PLA is generally set at 190-210 ° C, and ABS set at 230-240 ° C)
- ③ Nozzle clogged. Please try to briefly heat the print head to a temperature higher than 230°C and manually push the filament into the extruder. You can also clean it with 0.4mm nozzle cleaning needle. If it doesn’ t work, you may need to replace it.
- ④ Not enough cooling for the hotend.

Troubleshooting

- ⑤ The printer has been working above the maximum speed for a long time, please reduce the speed.
- ⑥ Check whether the extruder is normal and whether the friction force of the extruder to the filament is sufficient. Try to tighten or clean the extruder wheel.

4. Filament leaking

- ① Nozzle, heating block or throat tube is not tightened properly, try to fix/replace it after cooling or contact customer service.

5. Layer shifting

- ① Print head moves too fast, please slow down the print speed.
- ② Check the belts and driving wheels and ensure they are properly installed.
- ③ Drive current is too small.

6. No sticking to the bed

- ① The nozzle is too far from the platform, please try to re-level; at the same time set the "initial layer thickness" to 0.2 in Cura, and set the "initial layer line width" (for example, set to 150) to improve the first layer adhesion.
- ② Print too fast at the bottom layer speed, reduce it to ~20mm/s.
- ③ Ensure that the print platform is clean.
- ④ Add a brim or raft to the model in slicing software.

7. Freezing screen

- ① Please check if the soft cable above the screen is loose.
- ② Inspect if the touchscreen has been pressed by something.
- ③ Check if screen has cracks, if so, please contact our after sale service via official website www.anycubic.com

8. T0 sensor abnormal

- ① Check the wiring of the hotend and ensure a good connection.
- ② Check if there is any pins bent inside the connector.

9. Print head move abnormal

- ① The setting of machine type in slicing software is wrong. Please see page 17 to check the right setting.

10. Print stopped halfway

- ① Use print offline mode (memory card) instead of print online via data cable.
- ② Check if the GCode file is corrupted.
- ② Delete plugins in the GCode file.
- ③ The quality of the memory card is unstable. Try changing another brand memory card.
- ④ The power supply voltage is unstable. Please print again when the voltage is stable.

11. Some of the structure of the model cannot be printed

- ① If your model includes overhangs or bridges, you may need to add support on the model or adjust the angle of the model in the slicing software. It is recommended to preview the print layer to check the printability of the model.

12. Drawing is more serious

- ① The retraction distance is insufficient. It should be set larger in the slicing software.
- ② The retraction speed is too slow. It should be set a bit faster in the slicing software.

- ③ The printing temperature is too high, which causes the fluidity and viscosity of the filament to be strong. The printing temperature needs to be set a little lower.

13. Nozzle is too low or too high when printing

- ① Nozzle is too close to the platform, resulting in insufficient extrusion of filament. Click “Settings” → “Z offset +” to rise the nozzle.
- ② Nozzle is too high and the gap is large, which lead to poor adhesion of filament to the platform. Click “Settings” → “Z offset -” to lower the nozzle.

ATTENTION

1. Anycubic 3D printer generates high temperature. DO NOT reach inside of the printer during operation. Contact with extruded materials may cause burns.
 2. Use high temperature resistant gloves when operating the product.
 3. This equipment is not suitable for use in locations where children are likely to be present.
 4. The fuse rating for the printer is 250V 10A. Never replace the fuse with one of a higher amperage, otherwise it may cause fire.
 5. The socket-outlet shall be easily accessible.
-

Thank you for purchasing Anycubic products! Under normal usage and service, the products and its parts have a warranty period up to one year. Please visit support.anycubic.com/en to report issues with Anycubic products. Our professional after-sale service team would response within 24 hours and help you to solve the issue.